

The Unpleasant Relationship Between Reduced Household Growth and Municipal Housing Policy

Roland Goetgeluk ^a, Hans Heida ^b Co Poulus ^b and Roelf-Jan van Til ^b

^{a*} Research Institute OTB Delft University of Technology, P.O. Box 5030, 2600 GA Delft, The Netherlands; ^b ABF Research, Verwersdijk 8, 2611 NH Delft, the Netherlands.

Abstract

Recent demographic studies show regional differentiation in population and household growth in The Netherlands. For the first time some remote rural regions in the Netherlands witness a population decline. This decline has strong impacts on the labor force (size and composition), the viability of services, like education, health, public transport, shops, and the municipal tax-revenues. Clearly these changes will influence the location choice of housing consumers since the quality of location matters. In contrast the household growth is still very seldom negative due to processes of individualization, longer independent housing by elderly and so on. However, recent demographic data and prognoses show a sharp decline in the household growth with differs regionally. However, if less growth causes problem in housing policy since most intended investments in real; estate are based on the past prognoses of sheer size of demand. Constructing for long-term vacancies is clearly not acceptable and reasonable. Hence, risk assessments of present strategies relating to the management of the (social) housing stock, urban restructuring and countryside schemes, and construction schemes are at stake. In the contribution we will explain the effects of these changes on the basis of the former Overspill town Spijkenisse in the Rotterdam Area. The results are based on a joint contract research project of the Research Institute OTB and ABF Research, which also served to improve Primos.

Keywords: Shrinking populations/households, housing construction, ex ante evaluation match demand and supply, simulation models Primos.

DRAFT

NOT TO BE CITED WITHOUT PERMISSION OF THE AUTHORS

The content of this paper strongly resembles the content of the ENHR 2008 paper. That paper was not been presented. It seemed appropriate to present it at the ENHR 2009.

1. INTRODUCTION

Based on many conferences, stakeholder meetings, newspaper articles and indeed (contract) research a new star is born in Dutch housing policy: the shrinking growth of the population and households (Derks at al. 2008). Compared to many European countries the rate of decline is very moderate as figures 1 and 2 show. In absolute figures Germany, Italy and Poland have declining populations. In more general terms the former Eastern European Countries and the large Mediterranean countries decline rapidly. So, we may wonder if the developments in the Netherlands justify a cause for concern.

Figure 1: Population in millions EU 2005 (Source Eurostat 2008)

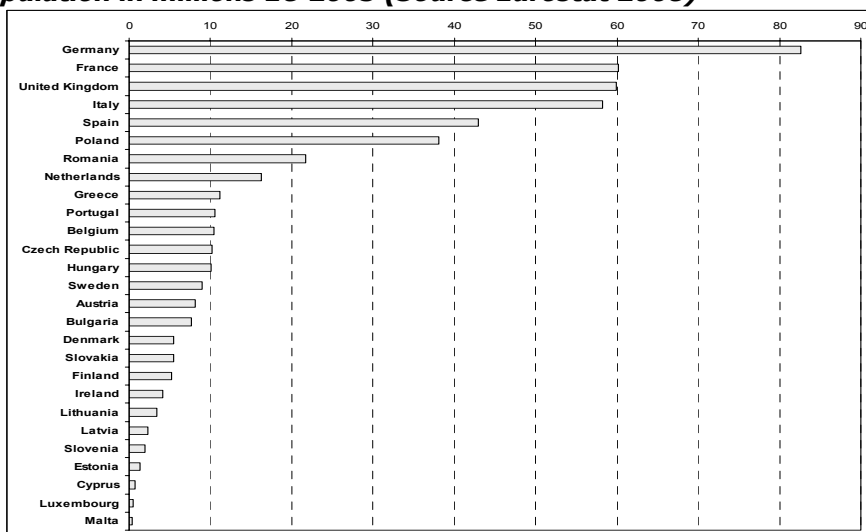
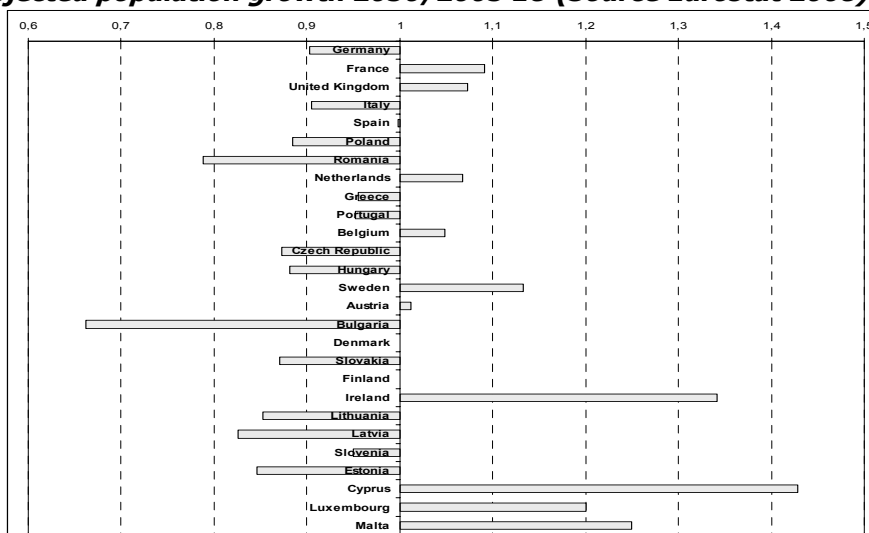

Figure 2 Projected population growth 2050/2005 EU (Source Eurostat 2008)



We will argue that indeed the decline of growth gives rise for concern on the housing market. The main reasons are that a lack of coordination in planning, a lack of

flexibility in new construction plans, a lack of financial balancing of cost and benefits at a higher administrative level than the stakeholders in risk, results in a prisoner's dilemma. Financial risks can be severe in a bear market and without coordination it is every man for him.

We will illustrate the negative effects at the municipal level due to a small decline of regional housing demand. The results are based on a recent concluded contract research for City Council of the former overspill town Spijkenisse in the Rotterdam area. We will argue that the coordination, organized at the provincial level, may reduce financial risks for households, project developers, housing corporations, municipalities and society as a whole. It is not a new argument. In 1992 former state secretary of Internal Affairs, De Graaff-Nauta, justly argued that the administrative scale and policy instruments should be in line with the functional scale in 1992. Although many have shown that the housing market region is the valid level, in many instances policy-makers still neglect it. However, a bear market may be the trigger.

The contribution is organised as follows. In the second section we link housing policy and the housing market system in an existing and widespread theoretical perspective. In the third section we describe the practical application of the theory. We discuss the model Primos, which simulates the match between demand and supply. In section three, we show the effects at local level of various local and regional scenarios of new construction of houses in a region with shrinking demand. The case study is the former Overspill town Spijkenisse in the Rotterdam Area. In the fifth section we elaborate on our recommendations for City Council of Spijkenisse in a wider perspective.

2. HOUSING POLICY, THE HOUSING SYSTEM AND DEMOGRAPHIC CHANGES

2.1 Housing policy as an instrument

Housing policy can be defined as 'a comprehensive and coherent set of financial and legal instruments in order to strengthen the social-economic, social-cultural orders and the occupation and livability of the built environment of people' (after Kreukels, cited by Geertman 1996). This definition links the housing systems to other systems like market for labor, culture, finance and so. Affordable housing prices reduce the levels of wages, clever allocated neighborhoods and infrastructure reduce commuting time and transport cost, and good housing and neighborhoods create satisfaction.

The valuation of the effectiveness of housing policies goes beyond the scope of the housing system, defined collectively as the housing market, the capital market and housing policy, itself. Positive and negative external effects are often calculated in a Cost-Benefit-Analysis (CBA). Modeling the distribution of households over the housing stock is a necessary step to create data for the evaluation models like a CBA. This implies that we need a sound theory and valid model to estimate the distribution over time and space.

2.2 Housing market as a filtering process

Successful housing policy implies that strategic changes are made in the housing system to improve the matching of demand and supply. Strategic choices imply that the system complexity is known and the link between the system level and the stakeholders' level, such as households, developers, housing corporations and so on. Central to this scientific discussion is the applied question of how macro-developments such as a lack of housing supply or households affect micro-behavior, such as the housing choice of individuals and the investment behavior of housing corporations, developers and financial institutions.

Based on much earlier work (Mulder & Hooimeijer 1999), individual housing choice not only depends in supply on the housing market, but also affects this supply. According to this model, supply is a characteristic of the macro level. The fact that long-term vacancies exist alongside waiting lists, suggests that price is not clearing the housing market. Characteristic of the housing market is that supply is generated for the most part by people moving house. This can also be referred to as filtering supply or vacancy chain supply. This concept postulates that primary supply, which refers to new construction, departure from the housing market (death singles, the move to care homes) and out-migration at the national level, triggers a chain (Filius 1993). A household that moves to primary supply may leave a house behind. If a mover occupies his former house, than another house becomes a vacancy. This 'chaining' process stops if a starter or migrant occupies the vacancy since they do not leave a vacancy behind. Within this framework we can define housing market policy as 'a comprehensive and coherent set of financial and legal instruments to optimize the filtering process in order to achieve the housing policy goals.'

The amount of secondary supply is considerable in the Netherlands. Yearly 10 percent of households move, that is 750,000 of which approximately 50,000 are new households. Secondary supply can be estimated by estimating primary supply. Nearly 45,000 occupy a vacancy as result of the death of singles and one-parent households; 25,000 houses become vacant due to moves to care homes and finally 60,000 houses are left behind due to out-migration. New construction is net approximately 60,000. Interesting is that Filius (1993) already pointed out that primary supply will be more and more the effect of demographic developments and more specifically aging and mortality. In short, primary supply is roughly 25 à 30 percent of the total vacancies. Despite that the lion's share of all supply is a macro-effect of the individual choices made by housing consumers, strategic primary supply is vital to achieve the goals of housing policy.

2.3 New construction in two markets: under pressure and in decline

The big issue is of course to determine what the goals of housing policy is to value the efficiency of strategic new construction. An important distinction between various definitions of demand: housing demand, potential demand, effective demand and housing need. They are often used abused. Housing demand is the sum of all (new) households. We can calculate this by means of population and household forecast. Potential demand refers to all people that like to, want to or must move. By means of surveys and stated preference models the volume and the preferences are estimated. Effective demand refers to the number of households that have moved

(revealed preference model) or the estimated choices people will make (state choice model). The difference between potential demand and effective demand becomes housing need only if it is valued negatively. The valuation has two elements: the test on effectiveness (housing policy goal) and the test on efficiency (instruments). In the framework of filtering this implies that the outcome of vacancy chain is valued by 'have all households irrespective to their income more or less the same access to the preferred dwellings' and by 'have we optimize the vacancy chain for this goal?' If market fails than state interference is necessary to create new market rules that the private stakeholders can apply. In short, the housing market exists by virtue of state interferences since the housing market is always imperfect due to its characteristics (Priemus 1984, VROMRAAD 2007).

The question is if market imperfections differ between a growing or declining population? And what happens if decline and growth occur at the same time? Housing markets are regional diverse (Goetgeluk & de Jong 2007). And if regional differences occur what does this imply for housing (market) policy instruments? As we will seen in section 4, the Netherlands faces absolute and relatives declines alongside growths.

In a regional housing market that is characterized by growing household population a common instrument is just new construction. In the Netherlands both valuation indicators score negative. New construction in the top segment of owning-occupying sector may lead to long vacancy chains, but the composition of the chain is not effective. As the VROMRAAD (2007) clearly shows, the social rented and the owner-occupier sector are separated submarkets; moving from rent to ownership is rather impossible and vice versa. One important factor is that the chain stops at the lowest part of the owner-occupancy sector. There is a lack of low priced owner-occupied houses. Due to the high prices in the existing stock and the residual land valuation that determine the price of new constructions, new construction is lacking behind. New construction in the rented sector is also needed. Housing construction for the lower incomes in the rented sector is not profitable since the gap between rent based the user costs and the social rent (rent policy) is large. The tenant is compensated for the difference (rent allowance), but the housing corporations have to finance the gap themselves. Since the mid nineties they are independent social-commercial organizations and do not receive much subsidies anymore. Investment in low prices rentals is risky. Despite that the sector is solvent, differences between corporations differ. Only by means of balancing the differences in risks can be solved. However, without a carrot and the stick solidarity fails.

In a regional housing market that is characterized by a declining household population the filtering process stops as well. An absolute decline does, but a relative decline that refers to less growth has the same result in the Netherlands. In declining markets the housing needs have to be solved by demolition and new construction at the same time. The study 'Krimp en Ruimte' (Van Dam et al. 2007) rightfully argues this. One vital analysis lacks: what is the logic of reduced wealth distribution and risk distribution (after Beck 1992). For instance, owner-occupiers are not able to sell their house for a necessary price or in time. Especially, elderly want to move around the age of 70. Luckily, many of them have redeemed their mortgage and therefore can

potentially accept a lower selling price than they expected. However, it remains to be seen if this rationality really works: sell at a loss is not attractive even if the price is sufficient to buy another dwelling. For tenants these problems do not exist; the housing corporations have to challenge the risks. Tenants have more opportunities and therefore can move. In a shrinking market long-term vacancies in the least attractive segments of the (social) rented sector may occur. Housing corporations will not be eager to create new supply unless the estimated revenues can balance the estimated losses. One method is to sell houses to the existing tenants. Selling implies a transfer of the risks to the private sector. If the value in the bookkeeping is much lower than the market prize, the profits can be used to finance new construction or demolishing. The various opportunities differ among housing corporations and regions.

Figure 3: Prognoses household growth 2005-2025 per municipality based on Pearl (Source Verwest et al. 2008, 017)

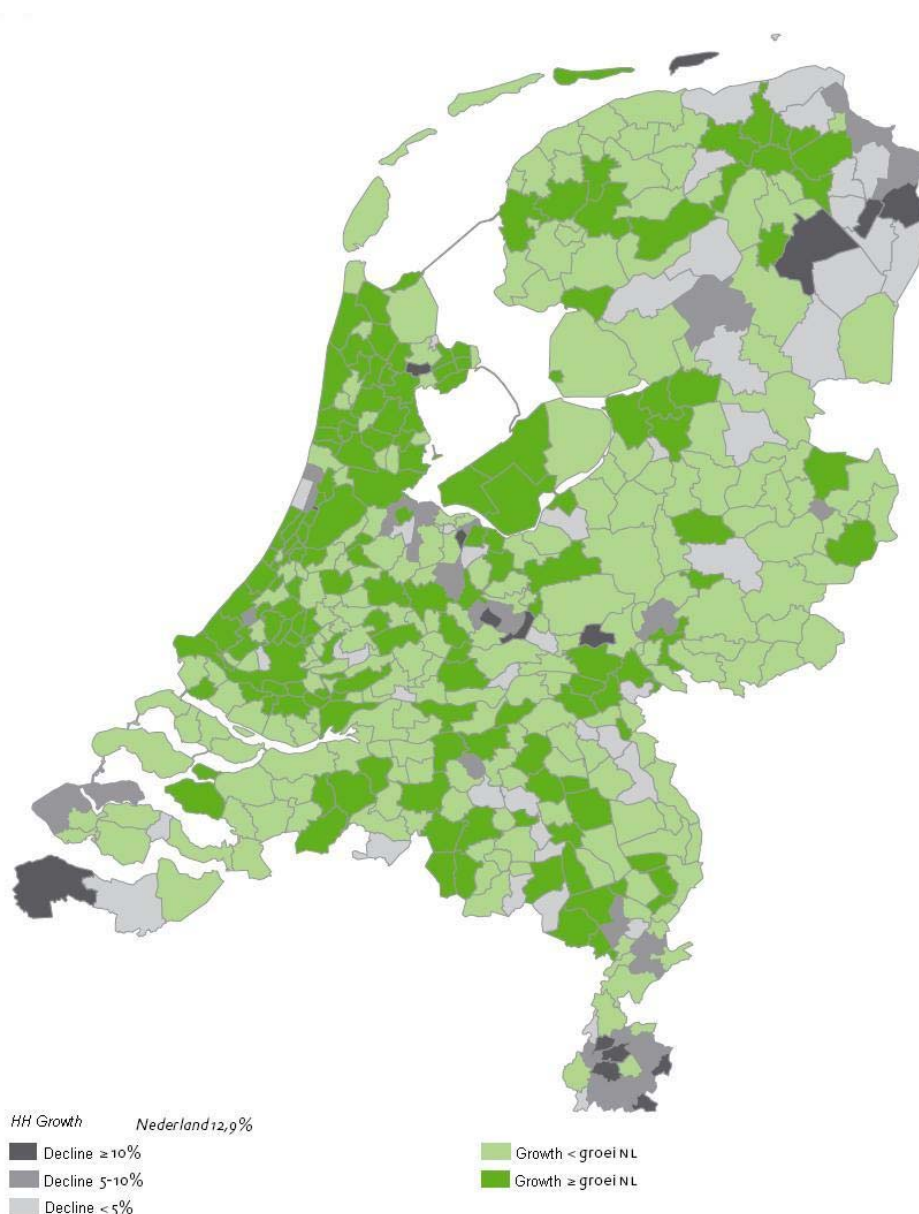

A shrinking growth of even absolute declines may have positive effects for housing consumers at first site. However, selling prices have dropped and long term vacancies exist in the owner-occupying segments. For housing providers, like housing corporations, municipalities, developers and so on, a large surplus casus financial losses. In spatial and social policy the effects are severe as well. The less attractive parts of the stock will suffer the most and therefore also the population. Often these parts of the stock are found in the older parts of central cities and growth-cities of the sixties/seventies. This implies that a reduction and a different composition of the stock are necessary. It also implies that reduction of new construction is important and a shift from building to reconstruction of the existing stock. A vital aspect is that municipalities do not compete in shrinking markets and act regionally. However, this cooperation perspective may differ between regions with an absolute decline and a relative decline. Accepting decline implies here marking down the assets. Because of the sheer size of the problem and the differences between various stakeholders, clear intervention and political leadership is necessary to trigger 'solidarity' and create institutional solutions like sink funds (amortization) (Verwest et al 2008).

In the Netherlands a major problem is the inflexibility of the spatial and housing policy planning system. Prepare an estimate and keeping within the budgets are two different things. We will give an example of the inflexible planning system and financing system. In 2005 housing construction agreements between the national government and municipalities were signed. According to former housing Minister Dekker, construction needed a boost to cope with the growing housing need. Regional Construction Agreements were signed. The time frames were 2005-2009 and 2010-2015. If the aims are reached, municipalities will receive (indirectly) subsidies to finance their prefinanced investments in for instance site preparation. The new construction agreements were based on prognoses of housing demand, potential and effective demand and housing need. However, demographic prognoses have changed, the economy is less blossoming and housing construction is less than expected. The aims are not reached and financial consequences occur. For municipalities the number of new inhabitants is important for the municipal budget. The General Benefit from the Municipalities Fund forms the bulk of the general resources of a municipality (Ministry of Internal Affairs 2008). The yearly budget is based on national expenditure of the state – if the state budget increases than the municipal budget increases as well – and some 58 indicators clustered in nice topic. Two very important clusters are 'Own revenues' (property tax) and 'Social', which refers to the population size, number of households, lower incomes, young and old people (Ministry of Internal Affairs, 2008). In short: richer, younger, employed, highly skilled and more people pays off.

In short, a declining household population has severe problems for the logic of reduced wealth distribution and risk distribution. Without any coordination a prisoner's dilemma exits. Showing solidarity with the other stakeholders is based on an interpretation of one's own interest in a complex system. And as prisoner's dilemma shows rationality is not always the case. The more a choice context is, the less rational trade-offs are made. Hence, instruments that inform the stakeholders to

decide more rationally are necessary. In the case of the housing market instruments that simulate the match between demand and supply is useful. In the next section we will describe Primos: a very often used model in the Netherlands.

3. HOUSING POLICY AND THE HOUSING SYSTEM: PRIMOS MODEL

3.1 In summary

In the 1970s, the Dutch government made substantial budgets available to stimulate housing construction. These funds were to be distributed among the municipalities in our country, based on a plan-based approach and as needed. As a result, a demand developed in the public housing sector for reliable forecasts for the development of the demand for housing. It was against this background that the Primos model was created some thirty years ago. However, the only thing about the model that has remained the same in all those years is the name. Under the 'hood', the model has been continuously improved and renewed. What started out as a relatively simple population forecasting model was quickly expanded to include a household model. Why? After all, the demand for housing is not determined so much on the basis of individual people as it is dependent on the number of households. Later, the model was refined from a municipal level to the level of postal code areas (at present, there are 443 municipalities and over 4000 postal code areas in the Netherlands). This refinement did justice to the fine-meshed and qualitative relationships, which exist on the Dutch housing market. Against the background of the integration debate, the Primos model was recently refined even further to incorporate the aspect of ethnicity.

Another one of the model's unusual features is that all of the characteristics (age, gender, household position and ethnicity) are fully linked, from a national level down to the postal code area level. This is important since the differences in ethnicity have an effect on all of the aspects: from births and deaths, via individualized behavior, to the demand for housing and migration behavior.

Although the technical aspects of the model continue to be refined even further, the model's basic approach - supported by numerous analyses - has remained the same. One of the model's central themes is the influence the housing market has on the spatial distribution within a specific region. Housing supply on its own does not attract people from the other side of the country. This is true. However, the supply of homes (quantitative and qualitative) does determine where the pressure will remain on the market within a region, and where people will move to as well as where the initial vacancies and stagnation will occur. Qualitative aspects of supply and demand also play a role in this, as well as distance (and information).

The special position occupied by housing supply and new construction within the Primos model results in outcomes which are heavily determined by housing construction (plans). The Primos model does not actually generate forecasts, but focuses more on pre-calculations which are determinative for housing construction. As a result, Primos consciously sets itself apart - and supported by analyses - from

other models which have cropped up in the Netherlands over the past thirty years which tend to place a heavy emphasis on the use of 'pure forecasting', without the influence of policy (a factor which simply does have an impact on housing construction in the Netherlands). The model is applied very frequently to calculate the effects of different policy options, particularly at local and regional levels. The scope and spatial distribution of the housing construction program is the specific 'buttons' which are pushed. The model then shows us which effects are based on a higher, lower, or different housing construction program.

3.2 General structure

The Primos model produces an integrated pre-calculation of the population and households at different regional scale levels. In this calculation, a differentiation is made within the population according to age, gender and position in the household as well as ethnicity. The model consists of three sub-models.

The *national model* predicts the number of residents and households for the entire country. Changes in household positions are partially the result of population changes. Other changes in households can occur without there being any change in the population. As a result, certain types of household transitions are modeled such as children leaving home, people co-habiting, divorce and shifts to care homes. The *inter-regional sub-model* allocates the changes caused by births, deaths, household transitions and inter-regional migration to the various municipalities. An algorithm has been developed to allocate the changes on a national level to the lower geographic scale levels. The municipal level is central to this allocation. The allocation to the municipalities essentially occurs in proportion to the population at risk for the relevant shift. In addition, the municipal differences in opportunities are also taken into account. The *intra-regional sub-model* predicts the intra-regional migration; developments in the housing market in particular play a role in this. Part of the allocation to the municipalities is conditional in nature. If the shift involving a child living at home to a one-person household is allocated to a municipality, then the change in the parents' household (one less child) is definitive. The new person living alone is, however, only assigned to the municipality conditionally. This person living alone will only find his or her definite position in the housing market migration.

Figure 4: The different geographical scales in Primos (excluding national level)

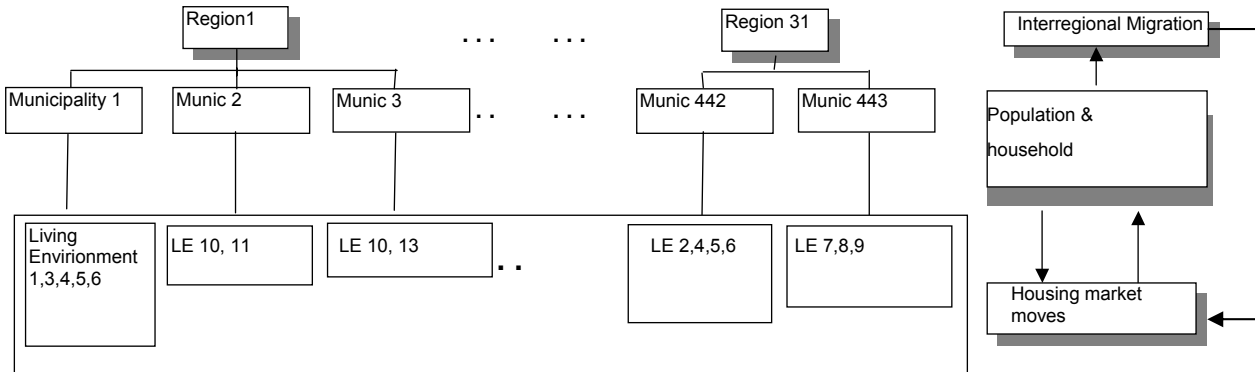

The municipality is the central geographic scale level in Primos (figure 4). Other levels are also taken into consideration in modeling the migration. Long-distance migration is modeled at a higher regional level, whereas a geographical scale level below the municipal level is considered for intra-regional migration. The reason for this is to take differentiation by type of living environment within (larger) municipalities into account. In municipalities in which several living environment types occur, an individual differentiation is performed. In practical terms, this means that in modeling intra-regional migration, differentiation does not take place among 443 municipalities, but instead among 4028 postal code areas, and according to type of living environment.

3.3 The national sub-model

Forecasting the number of births and deaths follows the classical cohort survival method. For births, age-specific and parity-specific birth parameters are assumed. For deaths, age and gender-specific parameters are used. Forecasting the number of foreign migrants requires little explanation. Foreign migration is differentiated according to age, gender, ethnicity, and position in the household. On the basis of the type of household, the number of migrating households is calculated using the number of people. The most advanced element in the national model involves the changes in households. This element is shown in figure 5.

In addition to the direct demographic processes in which the population undergoes changes as well, households also change because people in the existing population change household position. The demographic changes are shown on the right side of the diagram whereas the changes, which are primarily a result of changes in the household position, are shown on the left. Two distinctions apply here. Birth not only leads to an increase in the number of children living at home (arrivals), but also to a change in the parents' household (from co-habiting to co-habiting with child or from n children to $n+1$ children). Furthermore, deaths of co-habitants via widowhood also lead to changes in households for the surviving partner. The processes involved in changes in household position are leaving home, co-habiting, dissolution of relationships among co-habitants and shifts to and from institutional households. These processes are modeled through age-, gender- and ethnicity-specific functions, which describe the probabilities of shifts between household positions. One example of this type of function is shown in figure 6, for the transition from a child living at home to a one-person household for men of varying ethnicity.

Figure 5: Structure of the development of households

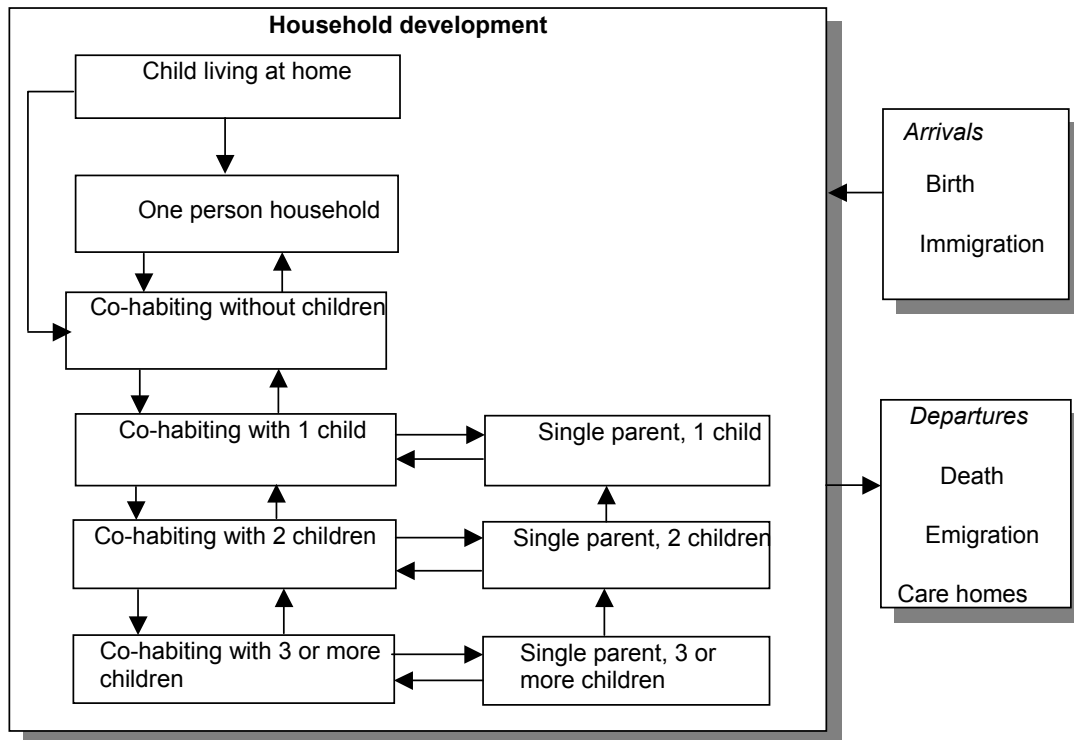
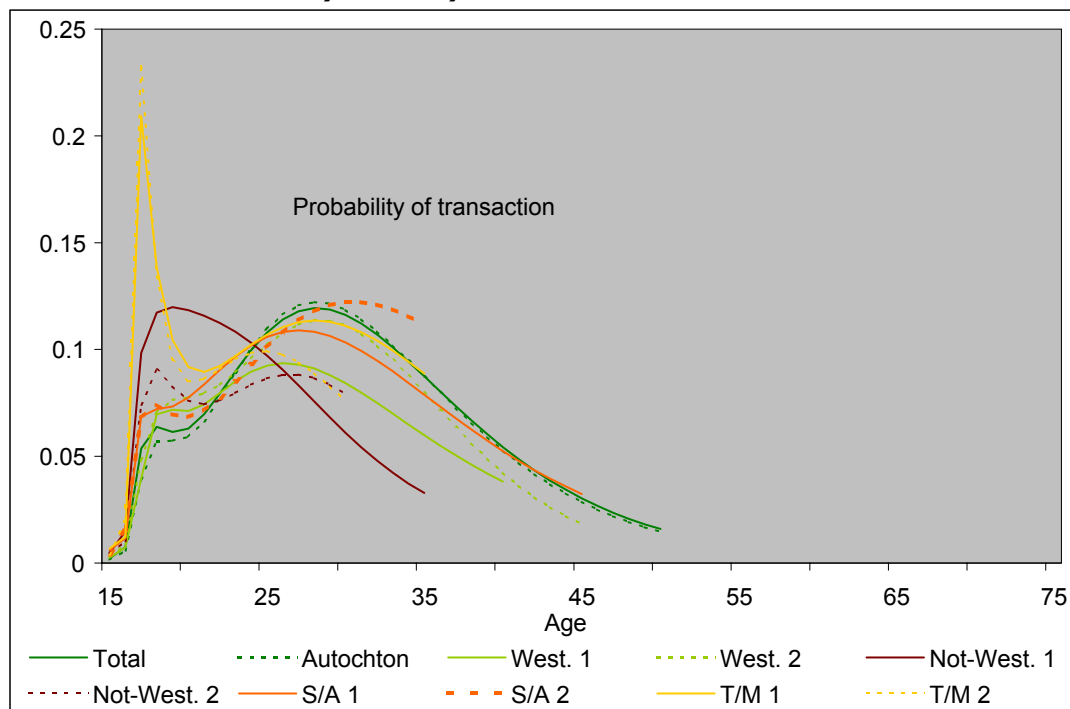

Figure 6: S probabilities in 2005 from "Child living at home" to "One-person household" for men differentiated by ethnicity



3.4 The inter-regional sub-model

The inter-regional sub-model has two functions. First, it allocates the outcomes from the national forecast to municipalities and second it predicts the inter-regional rate of migration. The number of births, deaths, foreign migrants and household transitions within the national model are distributed by municipal level here. The demographic 'changes' are, in principle, allocated to the municipalities in proportion to the population at risk. Moreover, municipal differences are taken into account by weighting the population at risk using municipal-specific parameters. These parameters show whether or not the fertility rate is higher or lower than the national average, whether the death risk is higher or lower and whether children leave the parental home earlier or later.

The foreign migrants are allocated to the municipality on the basis of the actual quantities, which have been counted in recent years. The municipal differences in births and deaths are determined on the basis of the figures from the past several years. The CBS (Central Statistical Office) provides sufficient statistical data in this regard. Municipal differences are only estimated when household shifts are involved. The CBS provides statistics on the number of transitions on a national level, yet not at a municipal level. At this latter level, estimates are generated on the basis of a) the national shift probabilities and b) the annual figures for the population according to household position.

In addition to births, deaths, foreign migration and changes in households, migration is also an important element. Two types of (internal) migration are identified within the Primos model. 1) Inter-regional migration which generally leads to long-distance migrations, the motivation for which is, to a large extent, attributed to the available facilities (such as work, education, care homes). 2) The housing market for migrations which occur over a relatively short distance and which are primarily geared toward finding (more desirable) housing. The inter-regional rate of migration is calculated in this part of the model. In the sub-model which follows, these migrants then find a definite housing location.

The inter-regional rate of migration is derived from the actual migration behavior over the past several years. In addition, a calculation model has been formulated that is based on three surfaces of a cube: 1) settlement by region according to age, 2) departure by region according to age, and 3) the to-from flows between the regions. The formula is the following:

$$M_{i,j,k} = Mgn_k * (Aik_{i,k} * Bev_{i,k}) * (Ajk_{j,k} * (Bev_j / \sum Bev_j)) * Aij_{ij}$$

Whereby

- $M_{i,j,k}$ = Migrants from region i to region j in age group k
- Mgn_k = Migration tendency for age group k
- $Bev_{i,k}$ = Population of age group k in region i
- $Aik_{i,k}$ = Relative departure tendency for age group k in region i
- Bev_I = Size of region j (in number of inhabitants)
- $Ajk_{j,k}$ = Appeal factor of region j for age group k
- Aij_{ij} = Relationship parameter between regions I and j

3.5 The intra-regional sub-model

Immigrants (from abroad) and inter-regional settlers (from other regions) are looking for housing. They must find a home on the housing market in addition to the demand from those within the region: starters (newly formed households in the region) and transfers (existing migration-disposed households in the region). Starters are the result of the modeling of the household shifts described above. The processes that contribute to this are those leaving home and the dissolution of relationships. In the event of co-habitation (of singles and/or single-parent families), a 'new' home will also have to be found in a number of cases. For each of the groups, the demand was distributed according to type of housing (rent-own home and ground-based apartment) and by type of living environment. The housing preferences of the various people looking for housing, which also lay at the basis of this distribution, were derived from a large-scale national study conducted among housing consumers (the WoonOnderzoek Nederland 2006, Ministry VROM 2008).

The supply of housing in the region is also compared with the demand. Three processes create supply: the departure of residents or discontinuation of households, new construction and finally the movement within the housing market. The first two processes are the same as primary supply, while the second is secondary. The number of households for which the residents depart or which are discontinued is known from the national and inter-regional sub-models. The new construction forms the input for the forecast and is thereby an important guiding parameter in the outcomes. The supply created through movements in the market is automatically calculated in this intra-regional sub-model.

Supply, demand and the interaction between supply and demand are calculated in this sub-model. Figure 7 presents this in graphic form. Supply and demand are geared to one another. Those looking for housing types that are readily available find housing quickly. Those looking for housing types that are scarce, will not all find the desired housing. Part of the households which do not succeed will respond by postponing their search (will look again in a subsequent cycle and/or the next year), whereas part of this group will elect to cancel their search (they will remain in their current homes), and the remainder will choose to adapt their search (they will shift their part of the demand to a less scarce housing type).

In this intra-regional sub-model, the developments in the housing market are central. Traditionally, developments in the housing market were dominated by quantities. Due to an absolute shortage of housing, every home was 'disposed of' in the market. Now that the problem in the housing market has shifted increasingly to becoming that of a qualitative task in which the (mis)match of qualitative supply and demand is central, in this part of the Primos model, the housing market is therefore also laid out in segments. Not only is a differentiation made according to type of housing (rent-own home and ground-based apartment), but a distinction is also made by type of living environment (from highly urban to rural).

Figure 7: Modeling migration in the housing market

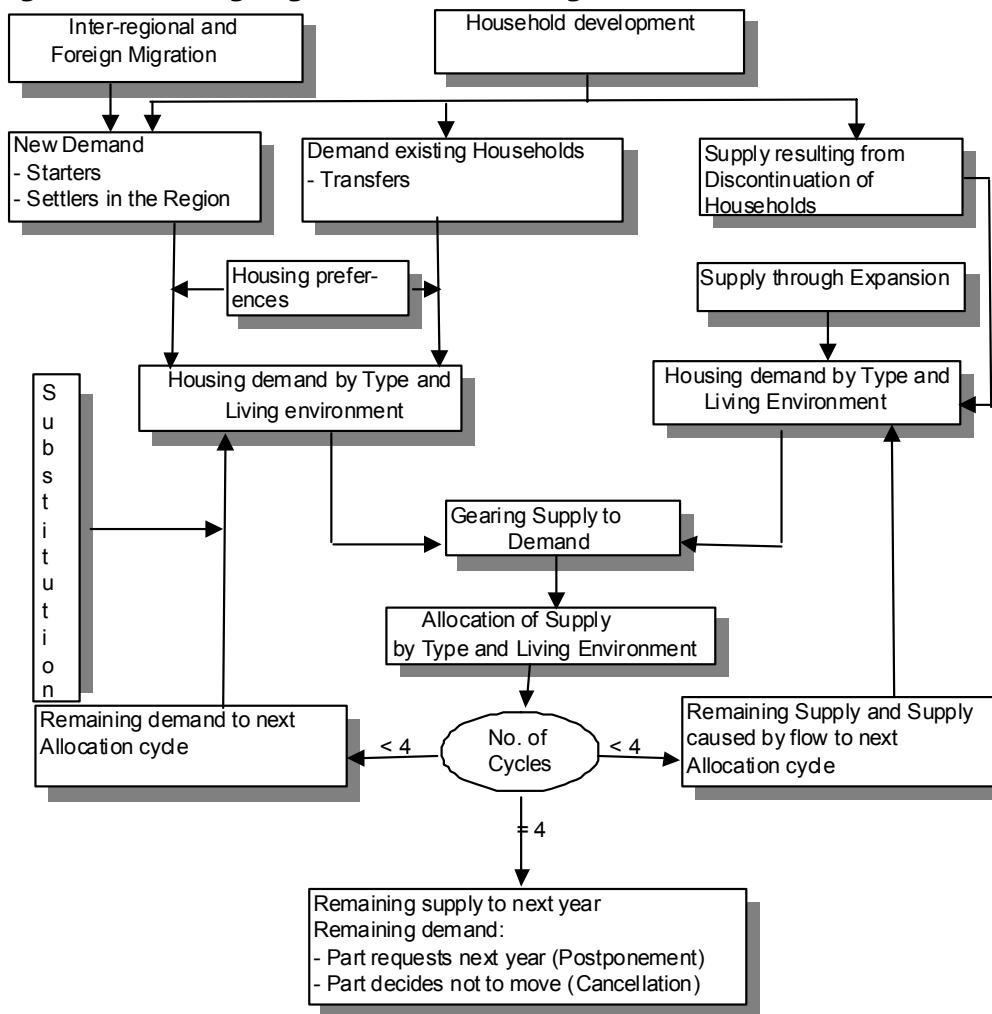

3.6 Beyond the models space

An acceptable model for a researcher is by no means a necessary condition for a successful advice. The final users, the decision makers, need a stepwise explanation how the housing market system works. Only then real trade-offs can be made. A good model must talk and the researcher's task is to help the policy-maker to make the talk walk.

4. THE CASE: ROTTERDAM REGION AND NEW TOWN SPIJKENISSE

4.1 The demographical context: moderate decline but spatially differentiated

We use the Primos 2007. If we compare the outcomes, they differ from the figures 1 and 2. The reasons are different model assumptions and newer data.

Based on the Primos 2007, in 2006, The Netherlands have 16.3 millions persons and this reaches its maximum in 2034: 17 million (VROM 2007). Around 2020 the growth

decreases rapidly. The natural growth (fertility–mortality) decreases due to lesser children and foremost a higher mortality rate due to aging. Aging is of course the important development for housing, the use of (commercial) amenities, the labor and the health market. Between 2006 and 2024 65 years and older will increase with 1.2 million. The age-group 35-49 will decrease between 2006 and 2026 with 845,000! Nowadays the net migration is negative: more people leave the Netherlands. This is partially related to Dutch and EU migration policies. Primos projects a positive balance of migration around 2012 due to a lower rate of out-migration. However, migration is always the tricky part in projections. The growth of the household population is different. In January 2006 the Netherlands have 7.2 million households and Primos projects 8.1 million in 2030. The average household size decreases from 2.26 in 2006 to 2.07 in 2030. Due to demographic processes, individualization and cohort effects, the volume of the age group 25-44 decreases in favor of elderly age groups. The Netherlands will have more small households and more elderly household with children.

Figure 8: Development in percentage of the population and households per municipality 2006-2030 (Source: Primos 2007)

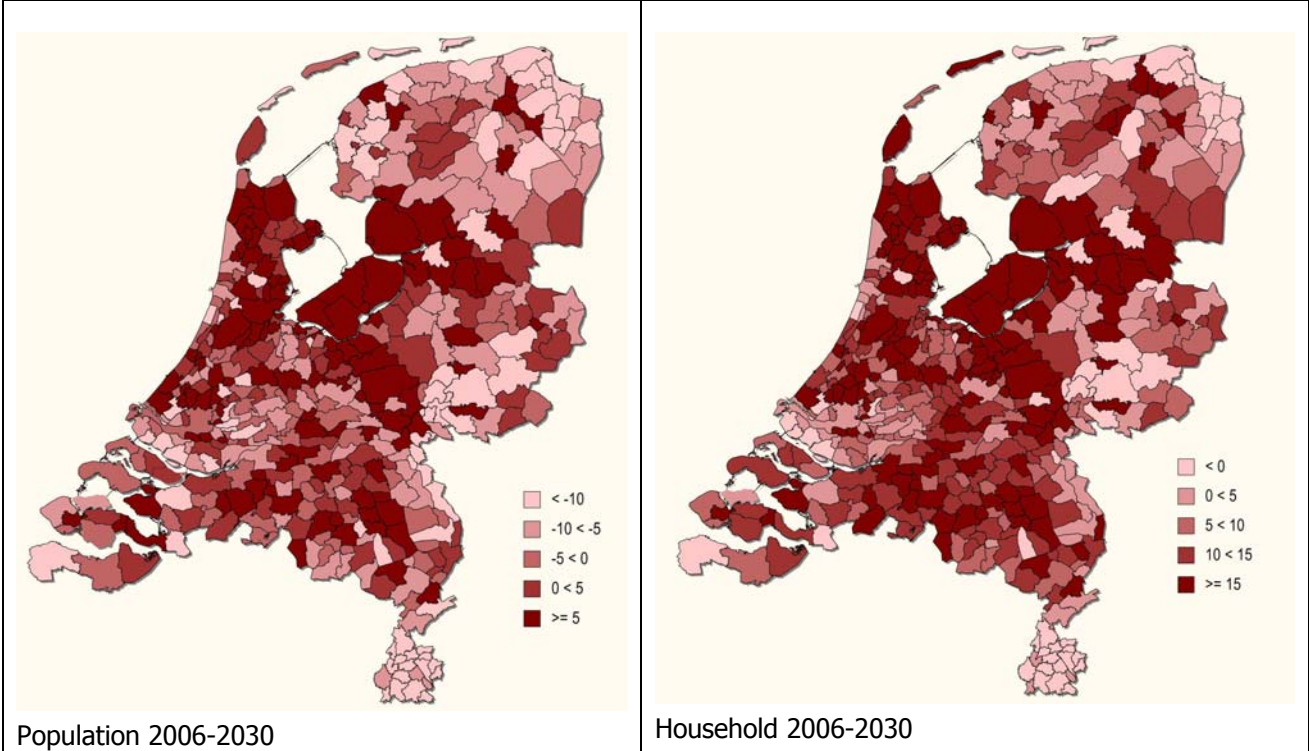

The geographical distribution of the developments is not even and random distributed (figure 8). The small province of Flevoland (the 'Isle' east of Amsterdam) and the province Utrecht will grow respectively with 20 and 9%. This has partially to do with large housing construction sites (VINEX) and partially to do with positive employment growth in these and their adjacent provinces. The regions in the north, east and south are confronted with absolute household population declines. These regions are also face severe lack of employment. Striking is the decline in the

Rotterdam region that stretches from the coast into the southern part of the Greenheart of the Randstad-Holland.

4.2 Problems in Spijkenisse

First, Spijkenisse is located in the Rotterdam region (figure 9). For many years this region copes with an extreme negative balance of inland migration due to less limited labor market for higher educated. But also the lower skilled and educated people, the Rotterdam region is less attractive. Due to technological innovations in logistics (container, ICT), traditional skills have become less important. The risk of unemployment is relatively high. Hence, many move elsewhere and especially for the better educated the Amsterdam and the Utrecht region are attractive. Despite the fact that they have to pay much more for housing, such a move pays off on the long run (Van Ham 2002). The out-migration may have negative effect on the labor market since especially services have thresholds. A recursive negative relationship may occur (De Graaf et. Al. 2008)

Second, Spijkenisse's is not accessible. It is located south of the New Waterway and the Calland Canal. Two small bridges and two tunnels are necessary to reach Rotterdam city and other parts of the Randstad-Holland. The motorway nearby Spijkenisse develops in a 'traffic-jam road' especially since the immense industrial site 'Maasvlakte' triggers more commuters. Compared to other locations its accessibility is not very competitive.

Third, Spijkenisse faces problems related to its former role as Overspill town. The Dutch Overspill Town Policy (1965-1985) was successfully to control urban sprawl. Up till 1990 230,000 houses were constructed. In the early nineties of last century the unintended negative effects of this planning concept were revealed. The young, educated and higher income groups left the central cities, like Rotterdam, and moved to towns like Spijkenisse. In the early years of the Overspill Town Policy towns like Spijkenisse took advantage. At the regional level the valuation was different. It resulted in an unbalanced distribution of household types over the Rotterdam areas, unbalanced uses of the housing stock in Rotterdam and the amenities. Furthermore, commuting flows increased because the suburbanization of firms did not follow until very recently (De Graaff et al. 2008). From 1988 a new planning doctrine emerged: Compact City. Instead of a controlled spatial distribution within conurbation, the central cities became the target. Revitalization of central cities and especially certain neighborhoods was at stake. Higher incomes had to be attracted by means of more owner-occupancy. On the other hand towns like Spijkenisse had to construct more social rented houses and house lower incomes. At the regional level this balancing makes sense, but at the local level this causes social, political and financial problems.

Figure 9: The Rotterdam Region and Spijkenisse and its types of living environments

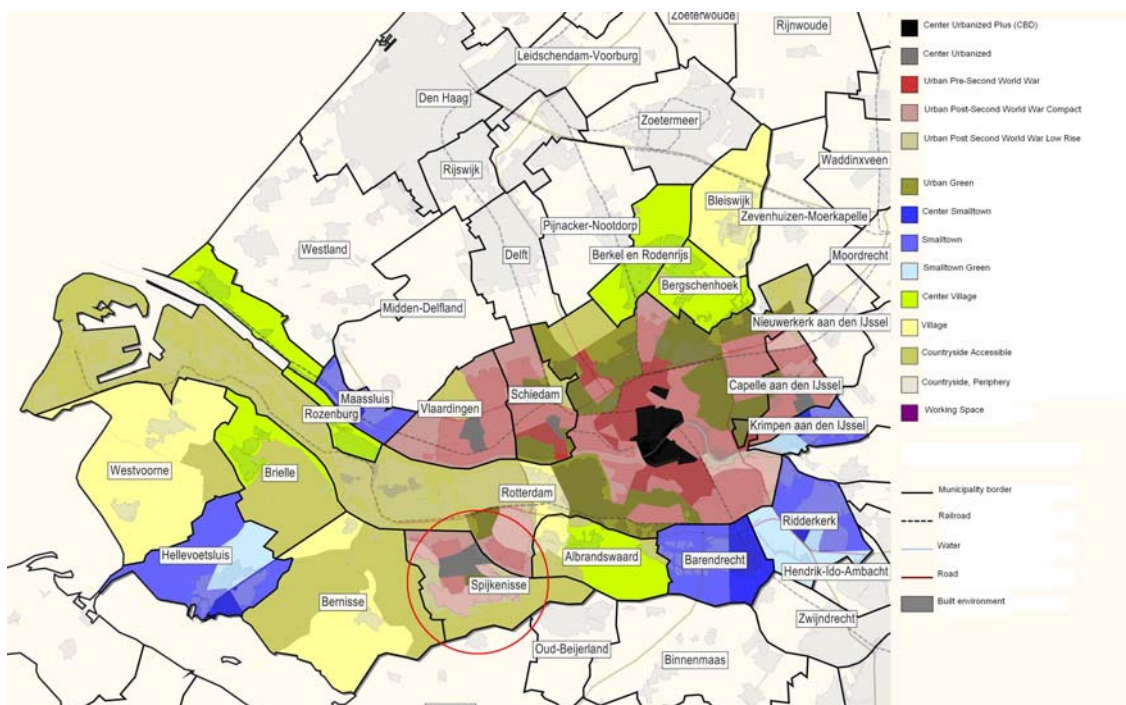

Too tackle these problems the municipality of Spijkenisse formulated a Housing Policy (Housing Vision) in 2004. To a large extent it has been influenced by agreements with the Ministry of Housing, Spatial Planning and the Environment (VROM) that were negotiated at the level of the administrative 'housing market region' Rotterdam. The agreements refer to the amount of new construction in the social rented and owner-occupying sector 2005-2009, 2010-2015, its distribution over all the municipalities within the Rotterdam region and so forth.

The recent household population forecast has shaken the Housing Vision to its foundations (see section 4.1). In 2004 the province estimated a new construction of 193,300 new houses. It has revised its volume to 158,000 for 2007-2020. The biggest revision is for the Rotterdam region. However, the new construction agreements and the municipal renovation and expansion plans in the region are based on a larger expected growth of the household population. The pressure on the housing market is decreasing and decreasing. Long-term vacancies are emerging and housing corporation and project developers postpone plans.

This postponement is a problem for the municipality and the city council. Why? The municipality spends on credit. To some extent the city council had to, to some extent it is the way politicians act. According to law, municipal profits on new construction can be used for all kinds of municipal expenditures Tax revenues are not targeted. Most profits are invested in preparing sites for building, but other expenditures are possible. Spijkenisse has invested in the revitalization of the commercial City Center. These expenditures are financially linked to new construction in a waterfront project. It consists of owner-occupying and social rented apartments. Based on recent forecast that match the recent experiences of the investors, some project developers

and housing corporations have contracted themselves out of a job. The risk of 'tomorrow never comes' is not acceptable for the municipality since the estimated profits cover the expenditures of the City Center! Hence, the municipality agreed to invest risk (tax) capital in the new projects. Under these conditions the project developers and housing corporations agreed to continue of course. If dead stock is the case, double financial disaster is at stake. By no means, this act of the municipality is exceptional. And frankly, municipalities have no alternative. Housing corporations and developers have port folios, which are not restricted to geographic-administrative borders as well. Municipalities are.

4.3 Approach

We used Primos 2007 to evaluate ex ante three constriction scenarios, which are vital parameter for the model. We received the data per year and per neighborhood (zip-code) specified by tenure (rent/ownership) and construction (single/apartment). The final date was 2020. By mutual agreement we have chosen:

- Scenario 1: the present local and regional construction scenario 2005-2009, 2010-2015 as points of reference;
- Scenario 2: an adapted scenario based on a regional analysis of the rate of construction 2005-2009. It turned out that the implementation lagged behind especially in the social rented sector for most municipalities. At a regional level the city councils to move the date of completion forward to the period 2010-2015.

We have calculated the demographic indicators (population by age and households by type) and housing market indicators. All indicators are valid at the municipal level although the match between demand and supply is done at a lower level by type of living environment and not by neighborhood. The most important housing market indicator is the tension. It refers to the difference between demand and supply. The difference is corrected for 2.5 % 'friction' vacancy. This friction is needed to make moves possible at all. So,

$$\begin{aligned} \text{Tension/pressure 1} &= \text{Potential Demand} - (0.975 * (\text{primary} + \text{secondary supply})) \\ \text{Tension/pressure 2} &= \text{Housing Demand (number of households)} - (0.975 * (\text{Stock} + \text{primary supply} - \text{demolition})) \end{aligned}$$

If potential demand consists of 100 households and supply consists of 100 houses, the tension is 2.5 houses. If demand and supply are only 10 % of the number of households and the stock, than the tension must be 25. If we take 2.5/100 and 25/1,000 we see that both have the same ratio's. Tension 1 resembles housing need in case it is valued negatively. Both tensions can have negative signs and in indicate long-term vacancies. Considering the input we have four tensions:

- Four tension 1 based on housing types (tenure * construction) and potential demand.
- One tension 2, based on the housing demand.

The tension is a hypothetical indicator. Why? Assume a large negative sign. This implies that long-term vacancies would exist. Assume that the model calculates these vacancies in the owning-occupying sector. Can this happen in reality? Unlikely! In the

Netherlands most mover move only if the present house is sold, although the bridging loans give the opportunity to have two houses for a short time. In the UK such a situation is impossible. In the social rented sector long-term vacancies may exist since tenants are not charged for a long-term vacancy of their present house. Hence, the tension indicator is hypothetical in the sense that it assumes that the vacancy chain even works in these circumstances of market imperfections. In reality long-term vacancies do not occur: people make decisions to reduce this risk. Therefore Primos serves as a warning system.

4.4 Results

The present composition of the stock

Between 1990 and 2007 the stock grew from 26,300 till 31.500 houses. Around 45% of the stock is social rented. Nearly 50% of rental sector is a single-family house. In the owner-occupancy most of the stock is a single-family. Between 2000 and 2005 the new construction is mainly owner-occupancy and single-family houses (both 70%).

Construction scenarios

Figure 10: Volume of two construction scenarios 2006-2019¹

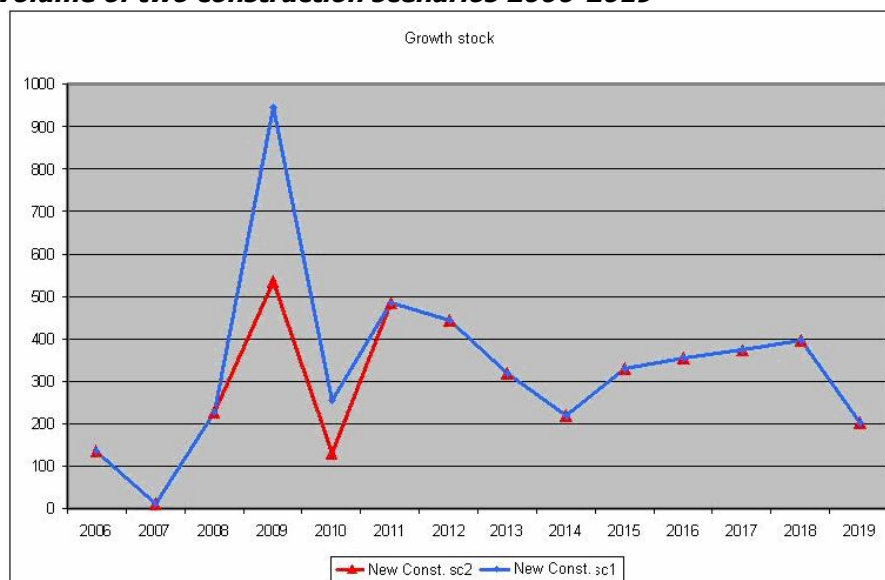

The figure 10 shows the construction scenarios. The biggest difference is between scenarios 1 and 2 until 2011. The peaks around 2010 are typical effects of inflexible planning system. Due to the delay in construction and the agreements, a tsunami of new houses must occur in 2009. Of course, this is nonsense, but for the municipalities this 'fake' reality is real. Primos show what the effects will be. It is not surprising that scenario 2 is more realistic, although we have argued that less construction is more likely. The city council refused to accept another scenario with a moderate volume.

Demographic developments and its effects

¹ Title Groei woningvoorraad= Growth Stock. Legend: nieuwbouw= new construction

The figures 11-13 show development of the population. The conclusion of figure 10 is that the decline of the population will not halt. Spijkenisse has to accept that decline is irreversible. Figure 10 also shows that scenario 2 is more effective: a small decline in population with a reduced construction volume. A major reason is the negative migration balance as indicated in section 4.1 (figure 11). We see immediately that new construction attracts more households, but the balance remains negative. Figure 12 shows that the age groups 30-39 and 40-49 migrate. These age groups have left, leave and will leave Spijkenisse as their housing preferences develop over the life course (Mulder & Hooimeijer 1999). The migration patterns, we analyzed show that Spijkenisse functions as a stepping stone in the housing career. For many Dutch households the highly preferred supply is: single family, garden, a view in a 'countrylike' environment nearby all necessary amenities. Heins (2002) called this pseudo rural living environments.

Figure 11: The growth of the population according to two construction scenarios 2006-2019²

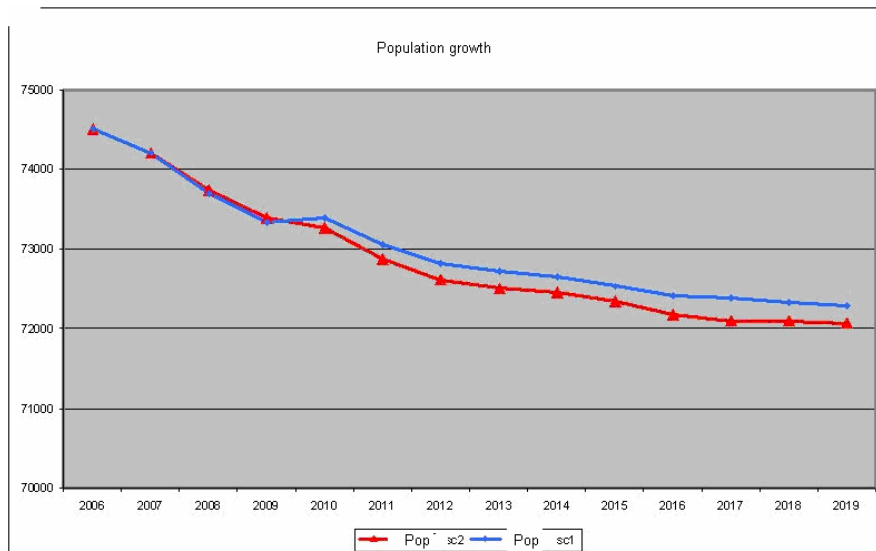
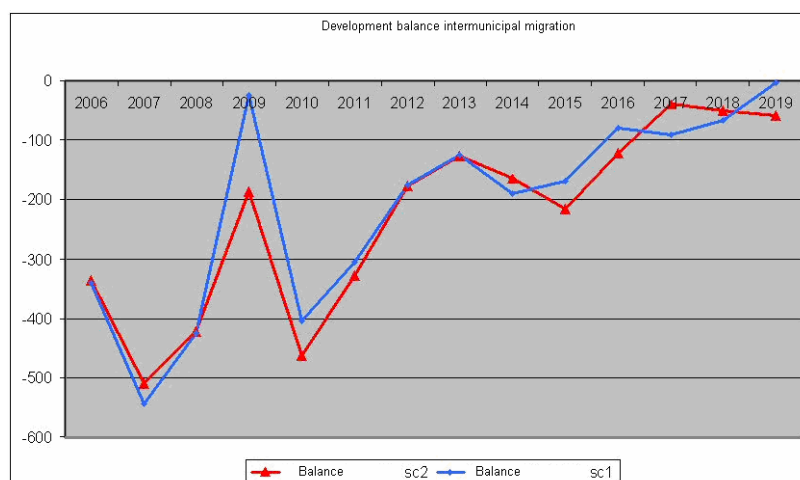

Figure 12: The development of the migration according to two construction scenarios 2006-2019³



² Title: Groei bevolking=growth population. Legend: sc=scenario

³ Title: Ontwikkeling binnenlands migratiesaldo=development inland migration balance. Legend: sc=scenario

Figure 13: The growth of the population by age groups according to two construction scenarios 2006-2019⁴

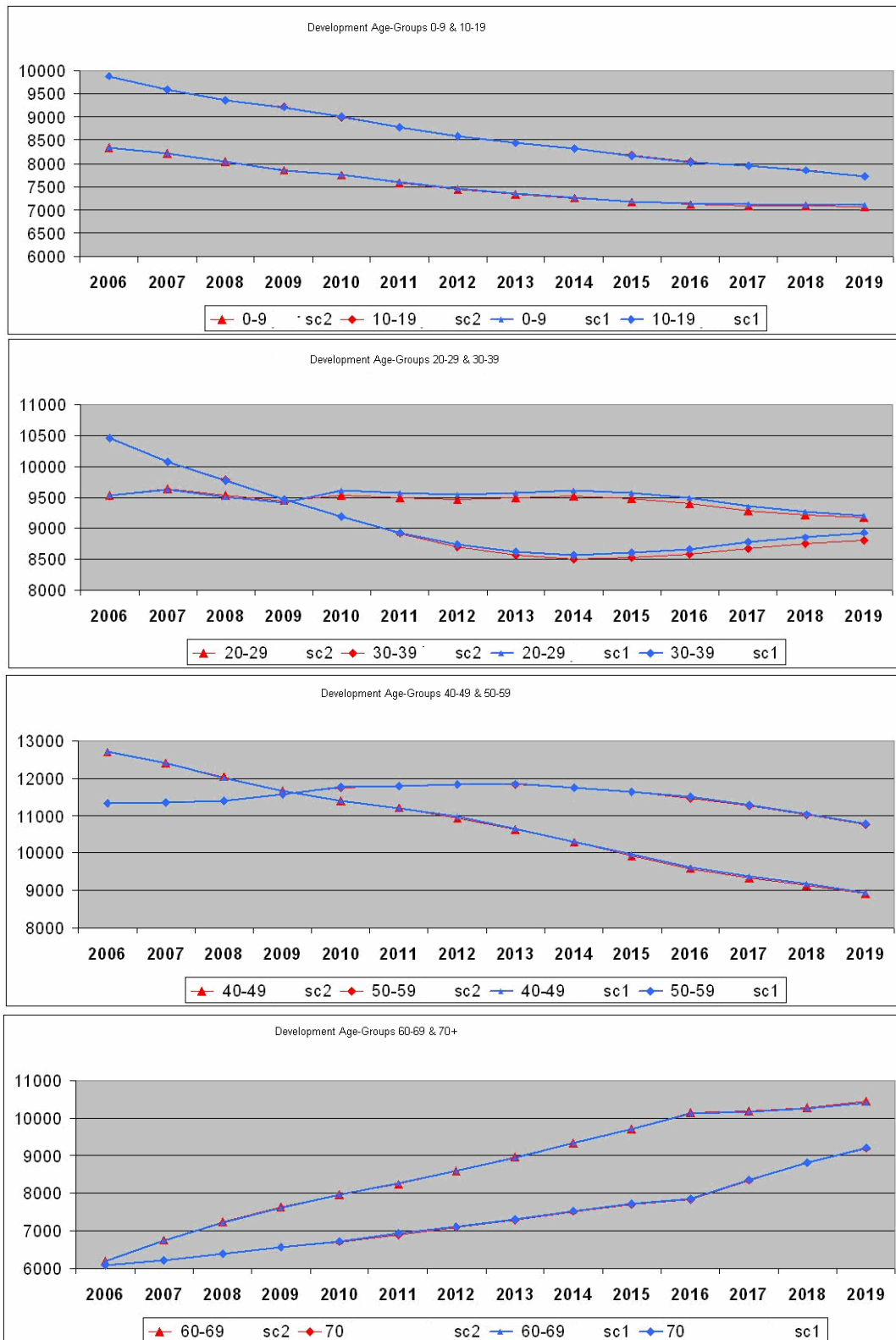

⁴ Title: leeftijdsgroepen= age groups. Legend: jaar=age; sc=scenario

Tension on the housing market

Figure 14: The household composition according to two construction scenarios 2006-2019⁵

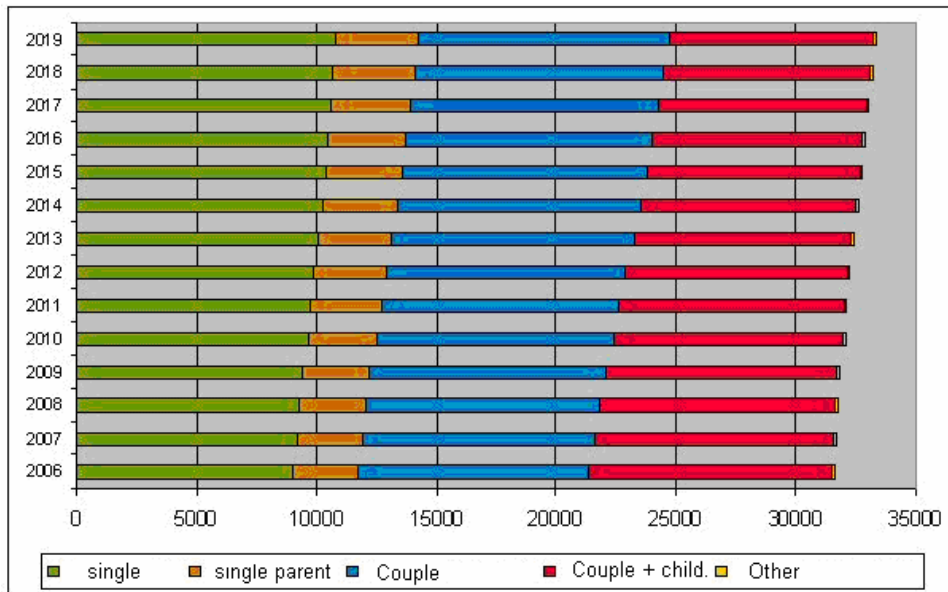
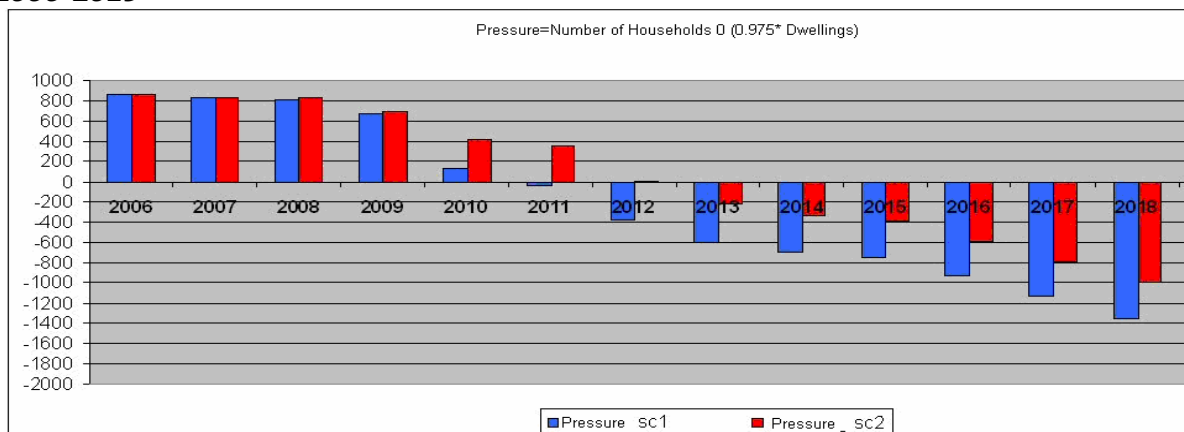

Figure 14 reveals the ageing of the population: singles and couples without children show an increase. Still, households with children remain rather stable. In combination with the ageing processes, this implies that on the long run policy must be developed to take care of the elderly. Given the good quality of the Dutch housing stock and its adaptability, this implies that the emphasis on means of extramural health care. Figure 15 reveals the real problem: the number of households grows less than the stock! If we take account of the tension based on the amount of household after 2012 the tension becomes negative. This implies the hypothetical long-term vacancies.

Figure 15: The pressure on the housing market according to two construction scenarios 2006-2019⁶



⁵ Legend: alleenstaand=single, eenoudergezin: single parent household, samen zonder kind: couples without children, samen met kind: couples with children, overig: other types.

⁶ Title: Spanning=huishoudens- (0,975 * woningen)= Tension = number of households - (0.975 * Stock). Legend: jaar=age; sc=scenario

Figure 16 shows the pressure (tension or mismatch) on the housing market based on potential demand and primary and secondary supply. Care should be taken at the x-axes, which that reveal surpluses (negative) and shortages (plus). The largest surpluses are found in the single-family houses in the owner-occupying sector. This is remarkable at first sight. However, it makes sense. Based on the dominance of single-family houses in Spijkenisse, the new construction, the negative inland migration balance especially for movers in the expansion phase (see figure 13 and 14) a surplus is to be expected.

Figure 16: The pressure on the housing market per housing type according to two construction scenarios 2006-2019⁷

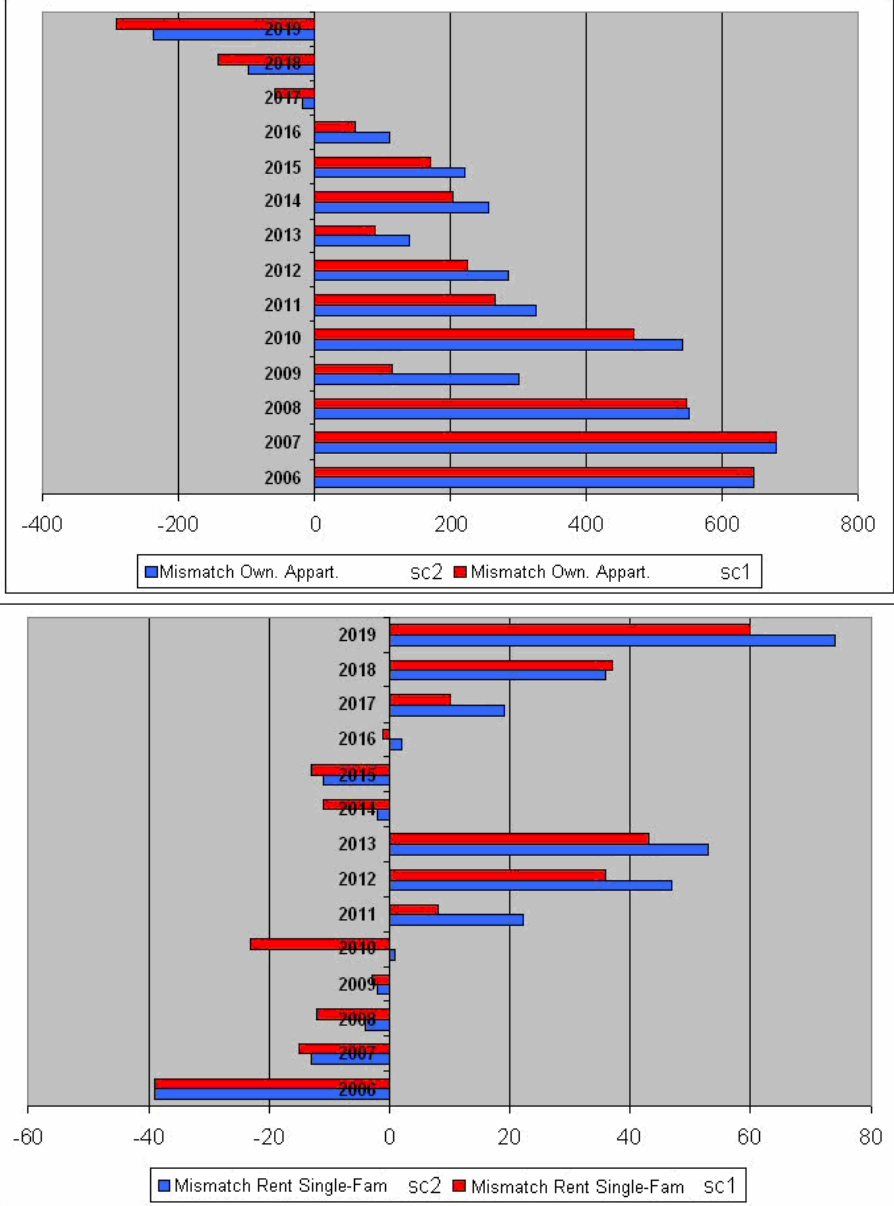

⁷ Legends: spanning=tension, koop=owner-occupancy; huur=rental; eengezins=single-family, meergezins;appartement

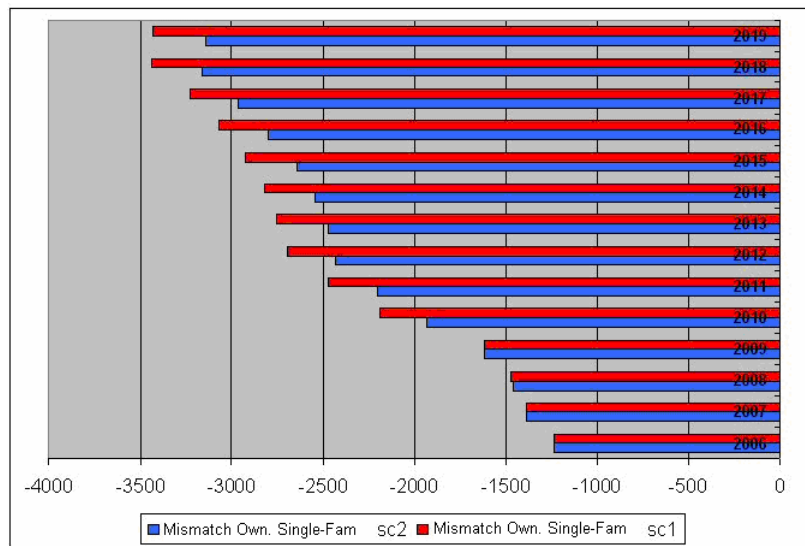
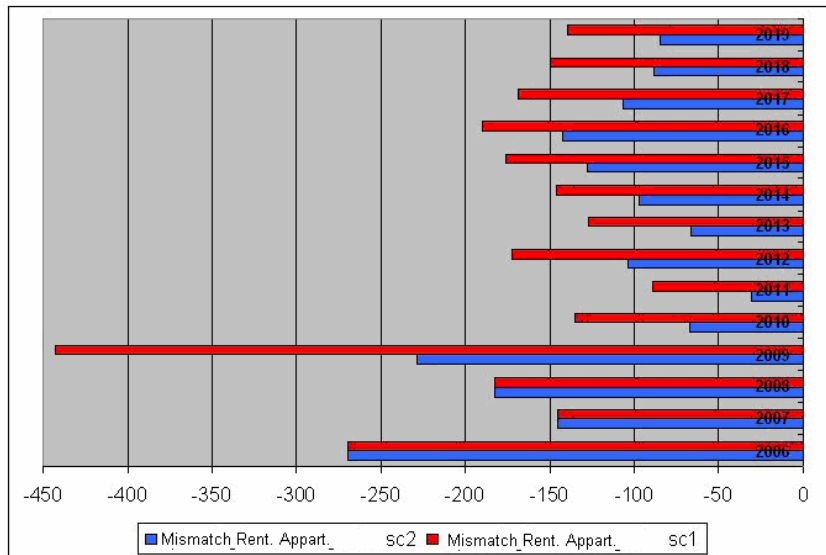

The implication of this indicator is very problematic. The city council rightly judges a potential demand for apartments in the owner-occupancy sector. The data shows however that potential demand originates from Spijkensisse itself. Hence, this implies that the buyers have to sell their present dwellings. As practice and our models result show, the chain will be interrupted. So, the new construction has competitive power, but unfortunately the system collapses due to a decline demand of households.

Municipalities like Spijkensisse, which face relative decline of demand, two stakeholders are extremely vulnerable: the owner-occupier and the municipality. The housing corporations and project developers face problems, but they have often large port-folios, assets and their negotiation power is strong. Therefore, the municipality could not choose but accept the proposal of these two other stakeholders to invest risk capital in the Waterfront project.

5. SPIJKENISSE USES THIS INFORMATION?

In December 2008 the municipality distributed the concept 'Housing Vision' (Woonvisie) (Spijkeniss 2008). The policy-paper states that the use of our research – the content of this paper- have been leading.

Spijkenisse defines itself now as the gateway between the urbanised part of the Rotterdam region and the countryside. Spijkenisse considers itself a regional service centre for the countryside. So, the perspective of being a growth-town has been substituted. As we have indicated Spijkenisse needs to present itself much better as a 'green brand'. In our view this new perspective seems sense. Spijkenisse considers elderly as an important market and marketing segment. Instead of addressing this segment as a demographic cohort that just evolves, Spijkenisse tries to attract it by offering services and its location as gate way to the countryside. We agree.

Spijkenisse has become aware that monitoring developments in the existing stock as a function of for instance new construction is vital. The system-approach which we have illustrated by means of the filtering process (vacancy chain) has been embraced. Therefore it is also aware that the effects of new construction must be evaluated ex-ante. As mentioned earlier, some neighbourhoods – often the least attractive ones- may witness a higher turnover and an influx of low-income households. Demolition and new construction to change the composition of the stock is proposed. More ownership, more inner-city greens areas and more direct links with the countryside, for example by means of new roads, is proposed. We agree.

Spijkenisse is aware that demolition, new construction and so on will have server financial consequences for housing corporations and households. Therefore Spijkenisse advocates constructions like a sink funds. Of course, the implementation will be extremely difficult, but the notion that such an instrument might be useful, is fairly positive.

The 'Housing Vision' lacks completely a number of scenarios concerning the volume and composition of the new stock and the filtering effects. One of our conclusions is that the volume and composition of the new stock must be reduced to reduce long-term vacancies. The vision lacks a clear perspective how Spijkenisse can act within the administrative Rotterdam region. Further, a financial paragraph is lacking which is problematic to evaluate if a vision is useful.

It seems that accepting the demographic shift from growth to decline is at stake, but implementing real strategies is a bridge to far.

6. FROM SPIJKENISSE BACK TO GENERAL SOLUTIONS

The Spijkenisse case is by no means an exception. We proposed a number of recommendations. There are two keys for success: act and manage regional and

share financial risks and opportunities regionally. In the last years, our contributions in research and advice both keys have become more and more important (Goetgeluk & de Jong 2004, 2007).

- *Regionalize local problems and opportunities*

The housing market is regional of character. The effects of changes in the housing stock in one neighborhood can only be estimated in the regional context. Political and professional leadership demands that city councils act regional. We can observe the genesis of real collaboration in the provinces of Limburg and Groningen. The collaboration is not restricted to municipalities, but other stakeholders, such as housing corporations, developers and so on, are involved. The invisible hand does not exit; direction is needed. The provincial and national government have vital roles. By law, the province can demand realistic construction schemes. By means of the carrot-and-the-stick municipalities and others can be stimulated to plan and implement better. The province itself should do be firm and consistent as well. Provinces should also use power politics towards the National Government. For instance the construction agreements should be flexible in planning and financing. Finally, some instruments, such as General Benefit from the Municipalities Fund, do not stimulate inter-municipal coordination at all. Regionalization of instruments is therefore a factor of success.

- *Financial solutions*

Reducing financial risks is necessary condition. In the region Holland-Rijnland, located nearby the City of Leiden and Parkstad-Limburg (ParkCity Limburg, Province Limburg), the municipalities have created a regional investment fund and regional payments structure. This will be difficult for the housing market since the spatial distribution decline of demand is unevenly spread. This means that a supra-municipal direction is needed. Another solution is to make profits in other markets than the housing market. Housing corporations more and more act as developers and manage other real estate. This allows them to gain surplus profits to subsidize demolition and or reconstruction. However, commercial developers have made complaints for the EU-commission since housing corporations compete unfair. For instance they do not pay VAT and transfer taxes. Finally, the government must subsidize financial gaps. It already does for a number of programs like het 'Grote Stedenbeleid' Large cities policy (GSB). There is no reason to expand this subsidy towards region in decline. In our study for Spijkenisse we argued that housing construction in the countryside is an option to attract new households since Spijkenisse does not use its 'countryside' at all. The profits which can be gained can be applied to demolish parts of the existing housing stock. Instead of new construction existing neighborhoods should become more attractive by adding green zones like parks. However, this strategy that has on one hand financial benefits and on the other improves the neighborhoods is forbidden by spatial planning (Goetgeluk et al. 2008, NIROV 2008).

- *Flexible management of supply*

Related to above aspects flexible planning is necessary. Housing construction is extremely regulated in the Netherlands. By law is it linked to spatial planning,

construction instructions and so on. Municipalities have to send their data on building request, permits, and finalization to the National Central Bureau of Statistics. Every year inconsistencies are traced (Dol et al 2008). And even if the data is valid, municipal organizations do not use these data for monitor purposes unlike housing corporations and developers. Likewise spatial planning should become more flexible than at the present. Global plans offer this. In a recent debate the rightful argument was used that governments should restrict its involvement in housing construction in defining minimal quality requirements. At the present the detailed involvement hampers flexibility (NIROV 2008). To optimize the filtering process certain parts of the stock need to be demolished (Goetgeluk et al. 2008, Derks et al. 2008). Demolishing is only useful if the present residents have an opportunity to move elsewhere. For tenants this depends on the strategic decision-making of the (social) land lord. For owner-occupants this step is impossible, unless a financial subsidy is available to sell their house.

- *Increase the social climate and provoke citizen participation*

In contrast to our expectations some neighborhoods perform better in a declining market. Due to the decline some neighborhoods become accessible for households, which before were not able to move. This is an opportunity for revitalization of certain locations. Political leadership is necessary to invite people to participate in the social climate.

Money, management, political courage at the local, provincial and national level is necessary conditions to tackle the problem of absolute and relative decline of demand. The willingness to invest in the built environment, either in town or countryside, are costly and based on long-term expected revenues for households, financial institutions, housing corporations and developers.

LITERATURE

Beck, U. (1992), *Risk society, towards a new modernity*. London: Sage.

Dam, F.van, C. de Groot & F. Verwest (2006), *Krimp en ruimte; bevolkingsafname, ruimtelijke gevolgen* [Shrinkage and space; population decline and spatial effects]. Rotterdam/Den Haag: NAI Uitgevers/Planbureau voor de Leefomgeving.

Derks, W., P. Hovens & L. Klinkers (2008), *De krimpende stad; ontgroening, vergrijzing, krimp en de gevolgen daarvan voor de lokale economie* [The shrinking city; ageing, shrinkage and the effects on the local economy]. Den Haag: NICIS.

Dol, K., H. van der Heijden & C. Lamain (2008), *Monitor Nieuwe Woningen* [Monitor New Housing Construction]. Delft: Onderzoeksinstituut OTB in opdracht van Ministerie van VROM, Nederlandse Vereniging van Projectontwikkelaars (NEPROM) en Aedes Vereniging van Woningcorporaties.

Faludi, A. & A.J. van der Valk (1990), *De groeikernen als hoekstenen van de Nederlandse planningdoctrine* [New Cities as cornerstone of Dutch planning doctrine]. Assen/Maastricht: Van Gorcum.

Filius, F. (1993), *Huishoudensopheffing en woningverlating in een vergrijzende samenleving* [Household dissolution and departure from the housing market in an ageing society]. Utrecht: Faculteit Ruimtelijke Wetenschappen Ph.D dissertation.

Geertman, S. (1996), Ruimtelijke planning en Geografische Informatie, zoektocht naar een GEO-IT methodologie [Physical planning and geographical information; a reconnaissance of GEO-IT methodology]. Utrecht: Faculteit Ruimtelijke Wetenschappen, Ph.D dissertation.

Goetgeluk, R., R. van Til (2008), Wat beweegt de Spijkenisser woningmarkt? [What moves the housing market of Spijkenisse?]. Delft: Onderzoeksinstituut OTB in opdracht van de gemeente Spijkenisse.

Goetgeluk, RW & Jong, T de (2007). What about the spatial dimension of subsidiarity in housing policy?. In P Boelhouwer, E Vogels & D Groetelaers (Eds.), ENHR Sustainable Urban Areas (pp. 1-17). Delft: ENHR/Onderzoeksinstituut OTB.

Graaff T. de, F. van Oort & S. Boschman (2008), Woon-werkdynamiek in Nederlandse gemeenten. [Dynamics in housing and working in Dutch municipalities]. Rotterdam/Den Haag: NAI Uitgevers/Planbureau voor de Leefomgeving.

Graafland, J. (2008), De juiste balans tussen beloning naar prestatie en gelijkheid [The legitimate balance between performance-related pay and equality]. Idee, jaargang 29, nummer 2, p. 10-14.

Ham, M. van (2002), Job access, work place mobility, and occupational achievement. Delft: Eburon. PhD dissertation.

Heida, H. & A. van der Meer (2007), Primos 2007; prognose model voor bevolking, huishoudens en woningbehoefte [[Primos prognoses 2007; the future development of the population, households and housing demand]. Delft: ABF Research in opdracht van Ministerie van VROM (technical report).

Heins, S. (2002), Rurale woonmilieus in stad en land; plattelandsbeelden, vraag naar en aanbod van rurale woonmilieus [Rural residential environments in city and countryside; countryside images, demand for and supply of rural residential environments]. Utrecht: Faculteit Ruimtelijke Wetenschappen, Ph.D dissertation.

Magnusson Turner, L. (2008), Who Gets What and Why? Vacancy Chains in Stockholm's Housing Market, European Journal of Housing Policy, 8:1, pp1-19.

Ministerie van VROM (2008), Primos prognose 2007; de toekomstige ontwikkeling van bevolking, huishoudens en woningbehoefte [Primos prognoses 2007; the future development of the population, households and housing demand]. Den Haag: Ministerie van VROM.

Mulder, C. H. & P. Hooimeijer (1999), Residential relocation in the life course. In: L. J.G. van Wissen & P. A. Dykstra (eds.), Population issues, an interdisciplinary focus. New York: Kluwer Academic/Plenum Publishers. Pp.159-186).

Spijkenisse, gemeente (2008), Concept Woonvisie 2010 - 2020 Gemeente Spijkenisse, Compleet Wonen. 18 december 2008

Verwest, F., N. Sorel & E. Buitelaar (2008), Regional Krimp en Woningbouw, Omgaan met een Transitieopgave. Rotterdam/Den Haag: NAI, Planbureau voor de leefomgeving.

VROMRAAD (2007), Tijd voor keuzes; perspectief op de woningmarkt in balans [Time for choices; perspective on the housing market in balance]. Den Haag, VROMRAAD, advies 064.

WEBSITES

Eurostat:

http://epp.eurostat.ec.europa.eu/portal/page?_pageid=1996,39140985&_dad=portal&_schema=PORTAL&screen=detailref&language=en&product=Yearlies_new_population&root=Yearlies_new_population/C/C1/C11/caa11024

Ministry of Housing, Spatial Planning and the Environment:

<http://international.vrom.nl/pagina.html?id=5450&ref=http://www.vrom.nl/pagina.html?id=19932&term=woon>

Ministry of Internal Affairs:

<http://www.minbzk.nl/onderwerpen/openbaar-bestuur/financien-provincies/gemeentefonds/verdeling>

Monitor Nieuwe Woningen:

<http://www.monitornieuwewoningen.nl/>

NIROV (Netherlands Institute for Spatial Planning and Housing): <http://www.nirov.nl/nieuws/388>

Parkstad, Limburg:

<http://www.parkstad-limburg.nl/index2.htm>

Province of Limburg:

<http://www.limburg.nl/nl/html/algemeen/beleid/ruimtelijkeontwikkelingvolkshuisvesting/ruimtelijkeontwikkelingvolkshuisvesting.asp>